

# JVC

D-ILA PROJECTORS

DLA-X900RKT

DLA-X700R

DLA-X500R

DLA-X35B



**4K**  
e-shift3



The Next Stage in 4K

**4K**  
**e-shift3**



## DLA-X900RKT

Reference D-ILA Projector with 3D Viewing

4K  
e-shift3

D-ILA

3D

1HX3D  
DISPLAY

tsf

- Industry's highest dynamic contrast ratio: 1,500,000:1\*
- Industry's highest native contrast ratio: 150,000:1\*
- Brightness: 1,300 lumens

\*As of November 1, 2013 JVC data.



## DLA-X700R

D-ILA Projector with 3D Viewing

4K  
e-shift3

D-ILA

3D

1HX3D  
DISPLAY

tsf

- Dynamic contrast ratio: 1,200,000:1
- Native contrast ratio: 120,000:1
- Brightness: 1,300 lumens



## DLA-X500R

D-ILA Projector with 3D Viewing

4K  
e-shift3

D-ILA

3D

- Dynamic contrast ratio: 600,000:1
- Native contrast ratio: 60,000:1
- Brightness: 1,300 lumens

# Original technologies to realize high-precision and high-definition 4K images

## Newly Developed Proprietary D-ILA Device

The exceptional picture quality of JVC projectors is achieved by the precision technology behind the company's original D-ILA devices. The latest device, which has an even narrower gap between pixels and is planarized, achieves brighter images rich with contrast. The device is optimally designed to complement ultra-high 4K resolution for precision image expression with virtually no screen-door effect.

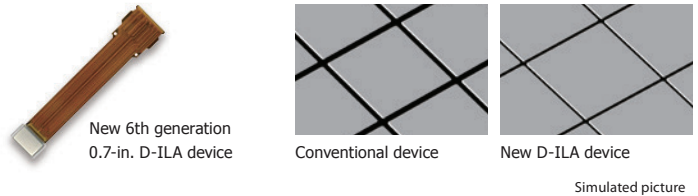

## New e-Shift 3 Technology

JVC's e-Shift technology shifts sub-frames by 1/2 pixel both vertically and horizontally to achieve 4 times the pixel density of the original content. Optimized for the new D-ILA device, the latest e-Shift 3 Technology boosts definition to a higher level.

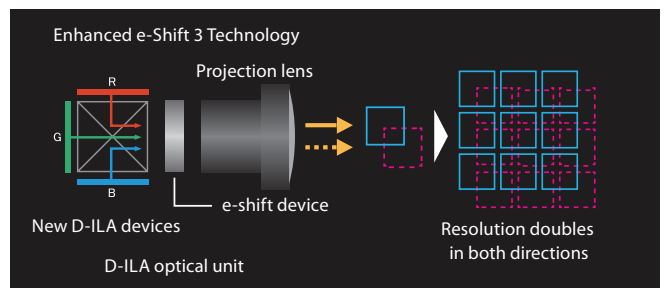

## Multiple Pixel Control

High-performance image processing technology is necessary for the precise reproduction of full HD sources on a 4K projector. JVC improved its Multiple Pixel Control technology featured on new models. In addition to wide-range picture detection and high-performance 8-band filtering,

Auto Mode has been added that performs frame adaptive filtering and picture generation to achieve a high-definition image optimal for a variety of scenes. Multiple Pixel Control lets the user experience immersive 4K images without complicated picture adjustments.

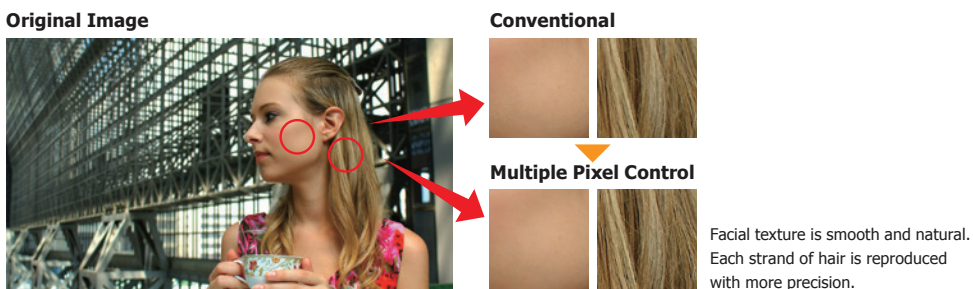
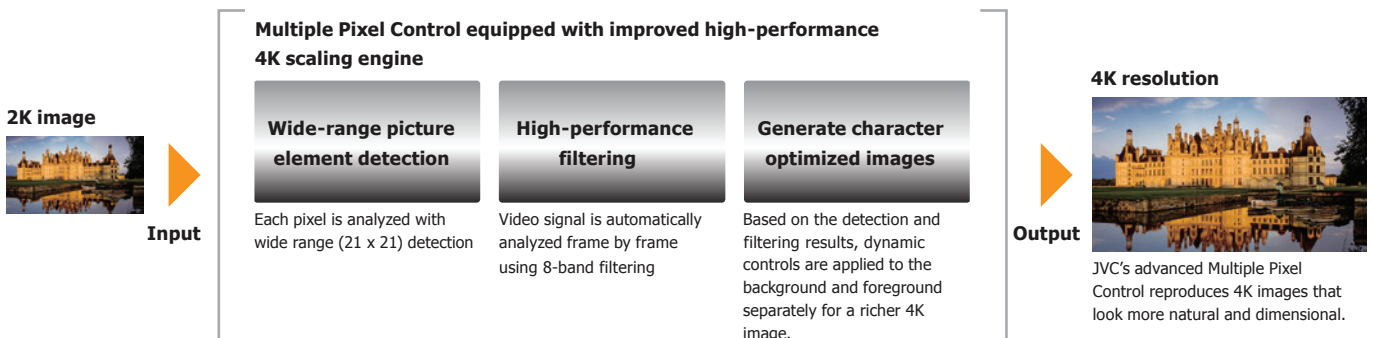

# Contrast and color imaging technology produce images with stunning reality.

## The Industry's Highest Dynamic Contrast Ratio of 1,500,000:1\* Achieved with the Industry's Highest 150,000:1 Native Contrast Ratio\*

The combination of JVC's original D-ILA device and an optical engine equipped with new wire grid to improve polarization performance results in the industry's highest contrast ratio of 150,000:1\*. What's more, the industry's highest 1,500,000:1\* dynamic contrast range is realized with the newly developed Intelligent Lens Aperture that optimally adjusts black level using an original algorithm to analyze the input video source, and Clear Black that boosts the contrast between light and dark. Enjoy high-definition video full of reality that can only be achieved with such a high native contrast ratio.



Conventional projector



DLA-X900RKT

\* As of Nov. 1, 2013, JVC data

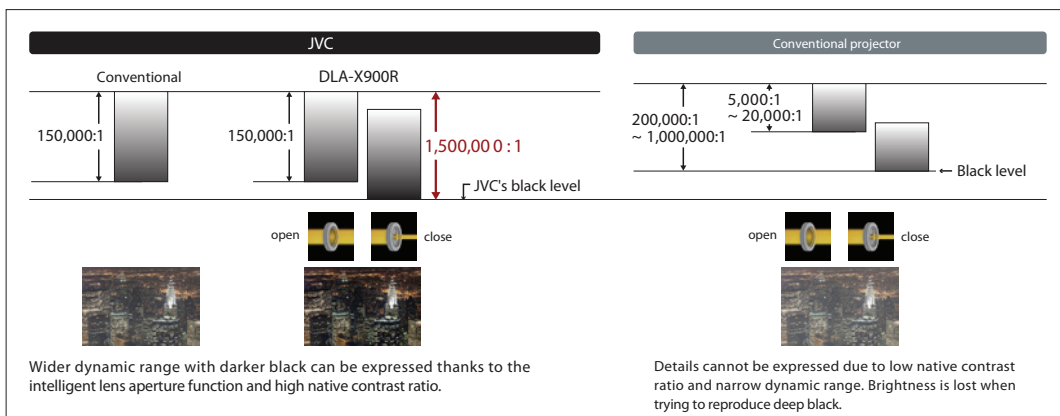

## Brightness of 1,300 lumens to Reproduce High Chromatic Purity

1,300 lumens brightness is achieved by virtue of a new optical engine equipped with new device that uses light more efficiently. A bright picture with high chromatic purity is realized thanks to optic design that excels in real-life usage situations.

## JVC's Unique Real Color Imaging Technology (DLA-X900RKT/X700R)

JVC original-development Real Color Imaging Technology realizes wider color reproduction and dramatically improves color rendition with settings for Xenon lamp color temperature and new dedicated color profiles. Combined use of picture quality modes and dedicated color profiles results in 23 different ways to enjoy high quality images.

### • Supports x.v. Color for Wide Color Space Reproduction

Featuring a color space wider than that of Adobe RGB or DCI, the D-ILA projectors vividly reproduce a fuller spectrum of colors such as the green of trees, the blue of oceans, etc., which is difficult to recreate accurately. Even wider "x.v. Color" color space is supported, enabling viewers to enjoy 4K video with rich colors incorporated in the original 4K source.

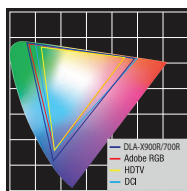

### • Featuring a Photo Mode that reproduces the texture of photographs

Picture Mode now features a new Photo Mode. Subtle textures and colors contained in still photos are precisely reproduced to enable dynamic pictures to be enjoyed on the big screen.

### • Xenon-lamp Color Temperature Setting

Supports a color temperature setting Xenon Mode, which is equivalent to that of a Xenon lamp, a popular light source used in cinemas. This setting allows for the authentic reproduction of colors similar to those of film in cinemas, while using highly efficient and economical ultra-high pressure mercury lamps.



Conventional color temperature setting



Xenon Mode color temperature setting

# Picture adjustment functions and convenient features

## Clear Motion Drive 3

Dramatic improvement has been applied to JVC's original Clear Motion Drive, including the adoption of a motion detection algorithm and high-speed LSI to drastically reduce ghosting or afterimage in high-speed scenes. This function works for 4K and 3D images to recreate clear and smooth movement in the picture.



Clear Motion Drive: Off



Clear Motion Drive: On

## Color Management System with 7-Axis Matrix

A 7-axis matrix of red, green, blue, cyan, magenta, yellow, and orange ensures the precise adjustment of hue, saturation, and intensity. Selection of the color spectrum such as skin tones can be easily performed.

## Screen Adjustment Modes

The projector selects the best mode to match the screen being used for images with natural color balance.



Screen adjustment mode Off



Screen adjustment mode On

\* Please refer to JVC website for a comparison table of primary screens and adjustment modes.

## Pixel Adjust Function

The Pixel Adjust function allows users to precisely correct color deviation in 1/16-pixel increments. It is also capable of segmenting the entire screen into 121 points and adjusting them individually to realize clearer video without color deviation. Two settings can be stored in the memory.

## Lens Memory Function

This function stores ten (five on X500R/X35B) separate lens adjustments for zoom, shift and focus that can be easily recalled when needed. Memory settings can be switched between each setup via the remote controller.

Lens memory examples (when using CinemaScope screen)



Memory 1: Standard 16:9



Memory 2: CinemaScope size



Memory 3: CinemaScope size with subtitles outside of the screen

## High Quality 3D Images of D-ILA

In addition to JVC's original Frame Addressing method to reproduce 3D images with vivid colors, the optical engine featuring a set of new D-ILA devices is capable of achieving more brightness. Furthermore, 3D image adjustment functions such as Crosstalk Cancelling are featured to offer the kind of realistic and exciting 3D images that only D-ILA can provide.



### RF (Radio Frequency) Method



PK-AG3  
RF 3D Glasses



PK-EM2  
RF 3D Synchro Emitter

### Notes about viewing 3D video content

- The optional 3D Synchro Emitter and 3D glasses are required to view 3D images from the D-ILA projectors. 3D video software (3D media or output of 3D broadcasts) and a 3D-compatible video player are also required.
- Perception of 3D images will vary with individual viewers.
- Stop viewing 3D images immediately if any discomfort such as headaches, dizziness, eye fatigue, etc. occurs.
- Viewing of 3D images by children under the age of five is not recommended.
- Read the Safety Precautions in the User Manual carefully before viewing any 3D source.

## Smoothly Control the Projector via a Smart Device

JVC D-ILA projectors can be controlled from smart devices such as smartphones and tablets. The smart device remote control app features an intuitive graphical UI and exclusive controls not found on the projector's supplied remote control for easy operation. Additionally, there are built-in help functions for smoother operation.

## Industry Certified Projectors — THX 3D Display Certification (DLA-X900RKT/X700R)

■ THX 3D Display Certification



■ Equipped with ISF (Imaging Science Foundation) Certified Calibration Controls (C3) mode



3D entry class projector enables high quality viewing even in bright living rooms by virtue of 1,300 lumens brightness and 50,000:1 native contrast.



## DLA-X35B

D-ILA Projector with 3D Viewing



- Bright picture realized with brightness of 1,300 lumens and native contrast ratio of 50,000:1
- Bright 3D viewing with reduced crosstalk only possible with D-ILA
- 6 Picture Modes and 3 Color Spaces
- Environmental Setting
- 5-mode Lens Memory
- 3 Screen Adjustment Modes
- Pixel Adjust by 1 pixel increment

### Feature Comparison

Model	DLA-X900RKT	DLA-X700R	DLA-X500R	DLA-X35B
4K e-shift <sup>3</sup> * 1	●	●	●	—
4K signal input* 2	●	●	●	—
3D capability	●	●	●	●
2D-3D converter	●	●	●	●
Multiple Pixel Control	●	●	●	—
Environmental setting	●	●	●	●
Picture Data In/Out* 3	●	●	●	—
Picture Tone	●	●	●	—
Pixel Adjust	● (by 1/16-pixel increment, 2 memories)	● (by 1/16-pixel increment, 2 memories)	● (by 1/16-pixel increment, 2 memories)	● (by 1-pixel increment, 1 memory)
Lens Memory	● (10 memories)	● (10 memories)	● (5 memories)	● (5 memories)
Clear Motion Drive	Ver.3	Ver.3	Ver.3	Ver.2
THX 3D Display Certification	●	●	—	—
ISF C3 mode	●	●	—	—
MPC Analyzer	●	●	●	—
Real Color Imaging Technology	●	●	—	—
Color Management	7-axis	7-axis	7-axis	—
Color Temperature (Xenon-lamp mode)	●	●	—	—
Screen Adjustment Mode	106 Modes (up to 255 modes)	106 Modes (up to 255 modes)	106 Modes (up to 255 modes)	3 modes
Clear Black	●	●	●	—
Darkness and Lightness Correction	●	●	●	—
Digital Keystone* 1	Vertical direction	Vertical direction	Vertical direction	Both directions
Anamorphic Mode	●	●	●	●
Intelligent Lens Aperture	●	●	●	—
Lens Aperture	● (16 step advanced)	● (16 step advanced)	● (16 step)	● (16 step)
Automatic Lens Cover	●	●	—	—

\*1 This function cannot be used while projecting in 3D mode. \*2 50p/60p compatible with 4:2:0 color base. \*3 Requires dedicated software as well as PC and LAN cables.

## Projection Distance Chart

Screen diagonal (inch)	Display size (16:9)		Projection distance	
	W (inch)	H (inch)	Wide (feet)	Tele (feet)
60	52.3	29.4	6.1	12.2
70	61	34.3	7.1	14.2
80	69.7	39.2	8.1	16.2
90	78.4	44.1	9.2	18.3
100	87.2	49	10.2	20.3
110	95.8	53.9	11.2	22.4
120	104.6	58.8	12.2	24.4
130	113.3	63.7	13.2	26.4
140	122	68.6	14.2	28.4
150	130.7	73.5	15.3	30.5
160	139.5	78.5	16.3	32.5
170	148.2	83.3	17.3	34.6
180	156.9	88.2	18.3	36.6
190	165.6	93.2	19.3	38.6
200	174.3	98.1	20.3	40.7

\*Projection distances are design specifications, so there is ±5% variation.

## Optional Equipment



### PK-L2310U

User-replaceable Lamp

Not suitable for household room illumination



### PK-AG3

RF Method  
3D Glasses



### PK-EM2

RF Method  
3D Synchro Emitter

## Connectors



DLA-X900RKT/X700R/X500R



DLA-X35B

## Specifications

		DLA-X900RKT	DLA-X700R	DLA-X500R	DLA-X35B
Device		0.7 inch Full HD D-ILA (1920 x 1080) x3			
4K e-shift3 Technology		●			—
Resolution		3840 x 2160* 1			1920 x 1080
Lens		x2 Zoom & Focus: Motorized; f=21.4-42.8mm / F3.2-4			
Lens Shift		±80% Vertical and ±34% Horizontal (motorized)			
Projection Display Size		60 inch – 200 inch (diagonal)			
Light Source Lamp		NSH 230W (lamp life: approx. 4,000 hours when the lamp is in Low mode)			
Brightness		1,300 lumens* 2			
Contrast Ratio	Dynamic	1,500,000 :1	1,200,000 :1	600,000 :1	—
	Native	150,000 :1	120,000 :1	60,000 :1	50,000 :1
Input Terminal	Component	—			1 (RCA;Y,Pb/Cb,Pr/Cr)
	HDMI	2 (3D/Deep Color/CEC compatible)			
Output Terminals	Trigger	1 (Mini jack, DC12V/100mA)			
	3D Sync	1 (Mini DIN 3pin)			
Control Terminals	RS-232C	1 (D-sub 9pin)			
	Remote	—			1 (Mini jack)
	LAN (RJ-45)	1			
Video Input Signal Format	Digital	480p, 576p, 720p 60/50, 1080i 60/50, 1080p 60/50/24, 3840 x 2160p 60/50/30/25/24, 4096 x 2160p*3 24			480i/p, 576i/p, 720p 60/50, 1080i 60/50, 1080p 60/50/24
	Analog	—			480i/p, 576i/p, 720p 60/50, 1080i 60/50
PC Input Signal Format (HDMI)		VGA/SVGA/XGA/WXGA/FWXGA/WXGA+/SXGA/WXGA++/WSXGA+/WUXGA			VGA/SVGA/XGA/WXGA/WXGA+/SXGA/WSXGA+/WUXGA
3D Format	Frame Packing	720p 60/50, 1080p 24, 1080i 60/50			
	Side-by-Side (half)	720p 60/50, 1080p 60/50/24, 1080i 60/50			
	Top & Bottom	720p 60/50, 1080p/24			
Power Consumption		360W (Normal standby: 7W, Eco-mode standby: 0.4W)			330W (Normal standby: 0.8W, Eco-mode standby: 0.4W)
Fan Noise		21dB (When the lamp is in Low mode)			23dB (When the lamp is in Low mode)
Power Requirement		AC100V-240V, 50/60Hz			
Dimensions (W x H x D)		17 7/8" x 7" x 18 1/2"			
Weight (net)		33lb		32.3lb	
				33.29lb	

\*1 Resolution is 1920x1080 at 3D mode.

\*2 Measurement, measuring conditions, and method of notation all comply with ISO 21118.

\*3 When the video input signal is at 4096 x 2160p, data above 3,840 is not displayed equally on the left and right.

## External Dimensions (unit: inches)

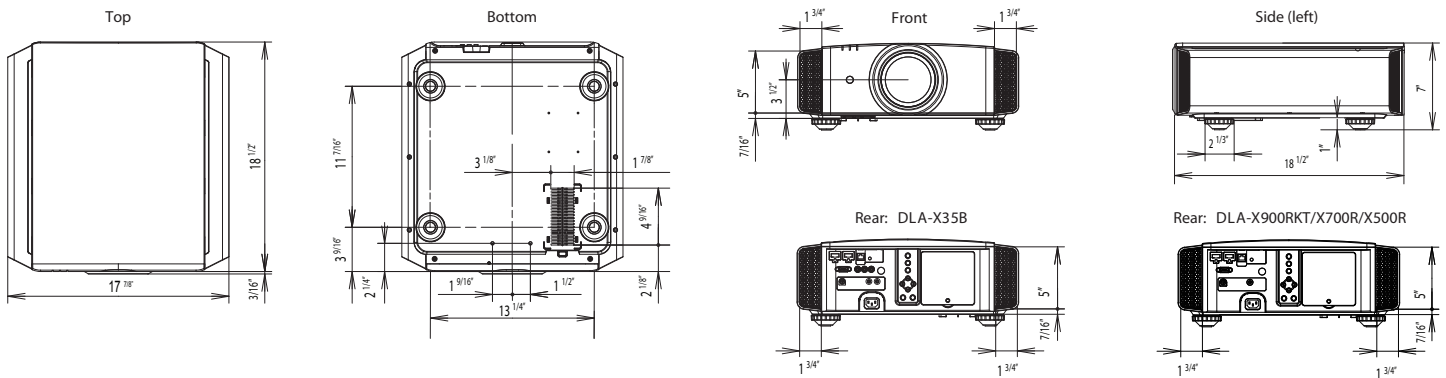

• D-ILA is a registered trademark of JVC KENWOOD Corporation. • e-shift is a registered trademark of JVC KENWOOD Corporation. • The projector is equipped with an ultra-high pressure mercury lamp, which may break, emitting a loud noise, when it is subjected to shock or after it has been used for some length of time. • Please note that, depending on how the projector is used, there can be considerable difference between individual lamps regarding how many hours they will operate before requiring replacement. • An additional payment is required for installation of a new lamp, if necessary. • The projector lamp requires periodic replacement and is not covered by warranty. • Please be aware, because the D-ILA device is manufactured using highly advanced technologies, 0.01% or fewer of the pixels may be non-performing (always on or off).

Design and specifications are subject to change without notice. All pictures on this brochure are simulated. Adobe is a trademark or registered trademark of Adobe Systems Incorporated in the U.S. and/or other countries. ISF is a registered trademark of Imaging Science Foundation, Inc. THX and THX logo are trademarks of THX Ltd., which may be registered in some jurisdictions. HDMI, the HDMI logo and High-Definition Multimedia Interface are registered trademarks of HDMI Licensing LLC. All other brand or product names may be trademarks and/or registered trademarks of their respective owners. Any rights not expressly granted herein are reserved.

Copyright © 2013, JVC KENWOOD Corporation. All Rights Reserved.



DISTRIBUTED BY

JVC Consumer A/V Group | A Division of JVC Americas Corp.  
1700 Valley Road, Wayne NJ 07470

"JVC" is the trademark or registered trademark of JVC KENWOOD Corporation.